

PLAN VIEW

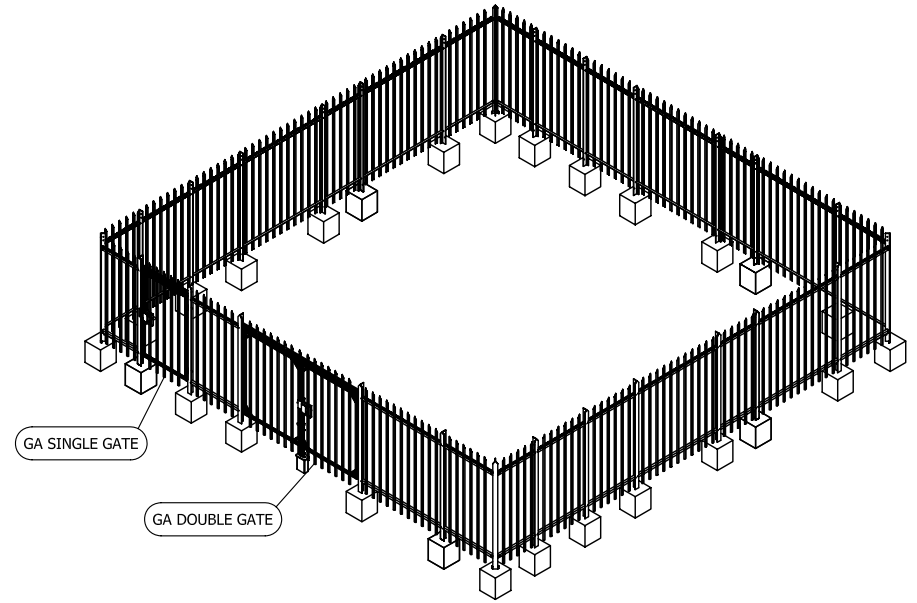

3D VIEW

D		DRN	KSRF	PRODUCT:	STDFN		
C		CHK	TRD.	TITLE:	GA. PLAN 10.00 M.		
B		APP	PK				
A	14/06/2010 (ORIGINAL)	ORIGINAL SCALE	1 : 75	@ A3 - DO NOT SCALE THIS PRINT	THIRD ANGLE PROJECTION U.N.O.	DRG.No	STDFN_210_1of3
ISSUE							

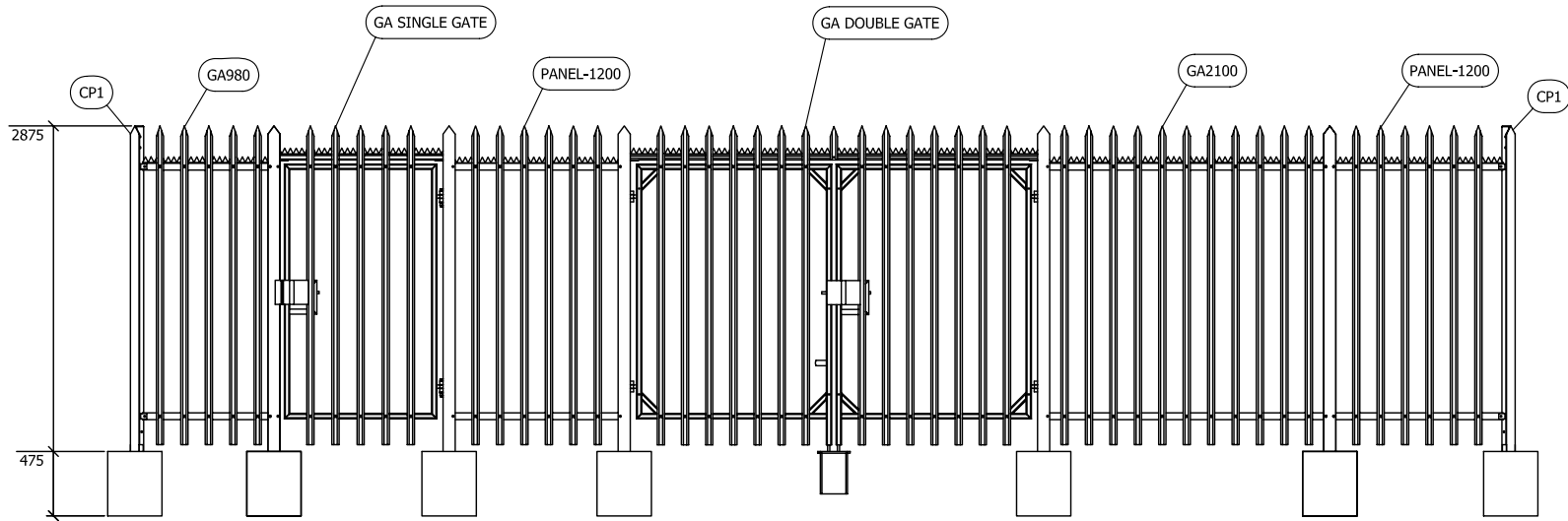

VIEW "A"

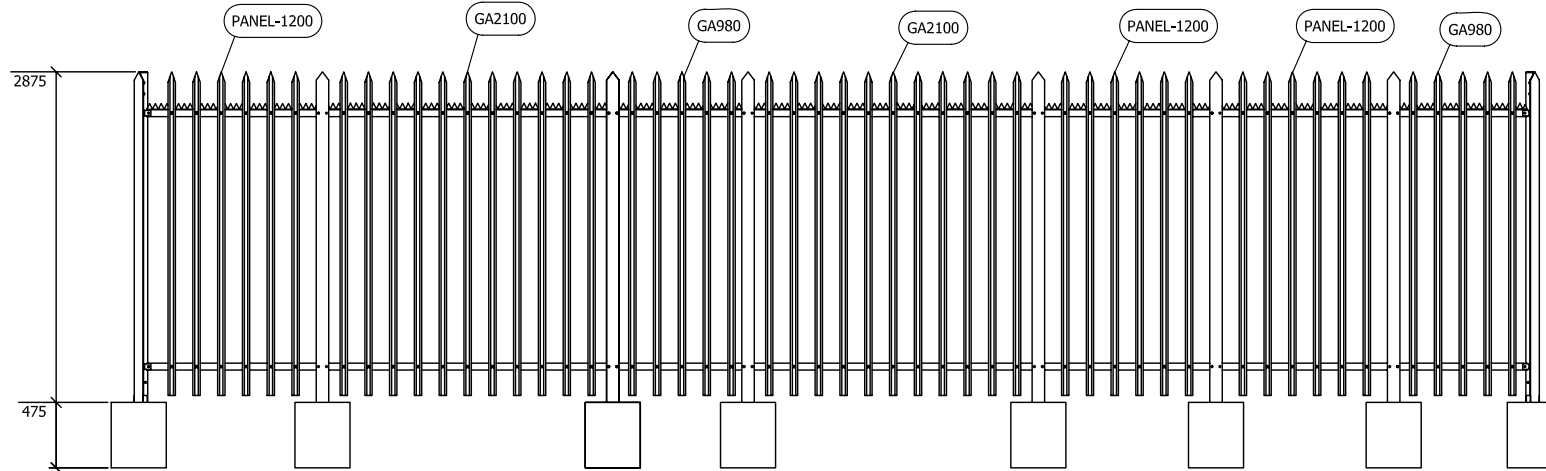

VIEW "C"

D		DRN	KSRF	PRODUCT:	STDFN			
C		CHK	TRD.	TITLE:	GA. PLAN 10.00 M. (VIEW "B0") & (VIEW "D")			
B		APP	PK					
A	14/06/2010 (ORIGINAL)	ORIGINAL SCALE	1 : 75	@ A3 - DO NOT SCALE THIS PRINT	THIRD ANGLE PROJECTION U.N.O.	DRG.No	STDFN_210_2of3	
ISSUE								

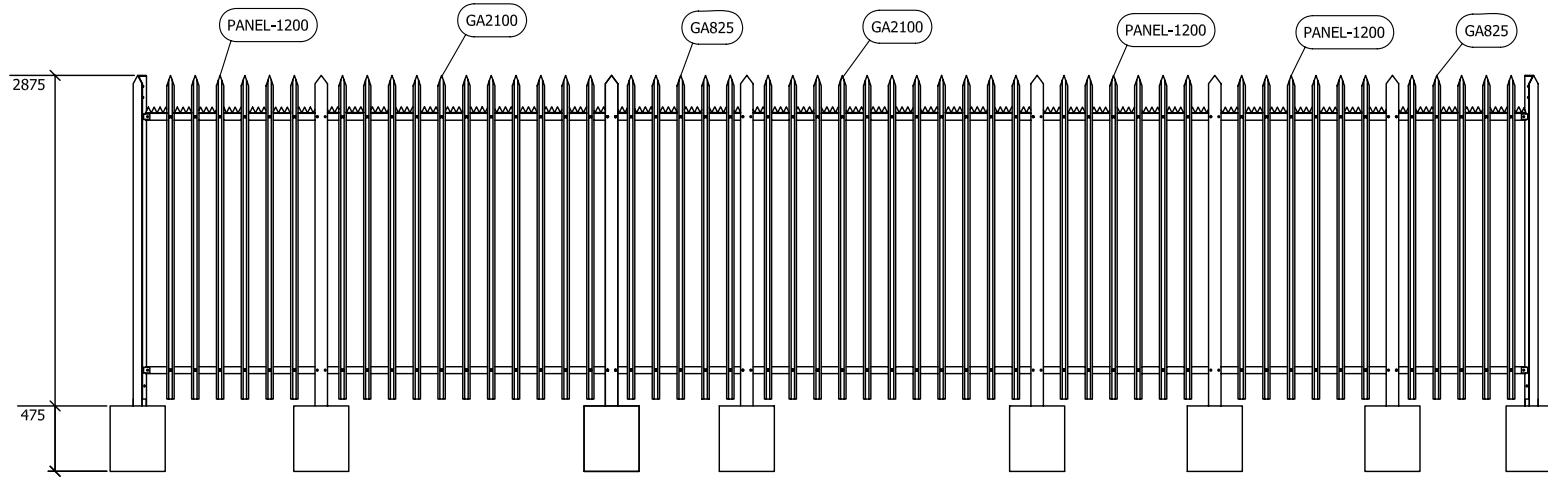

VIEW "B"

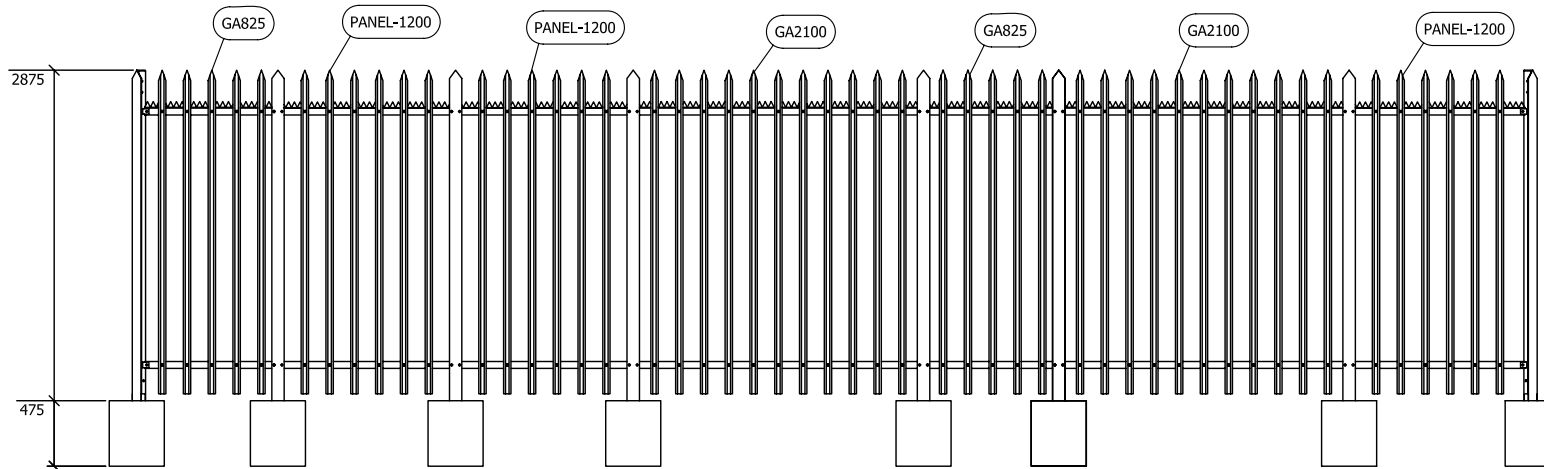

VIEW "D"

D		DRN	KSRF	PRODUCT:	STDFN			
C		CHK	TRD.	TITLE:	GA. PLAN 10.00 M. (VIEW "A") & (VIEW "C")			
B		APP	PK					
A	14/06/2010 (ORIGINAL)	ORIGINAL SCALE	1 : 75	@ A3 - DO NOT SCALE THIS PRINT	THIRD ANGLE PROJECTION U.N.O. 	DRG.No	STDFN_210_3of3	
ISSUE								

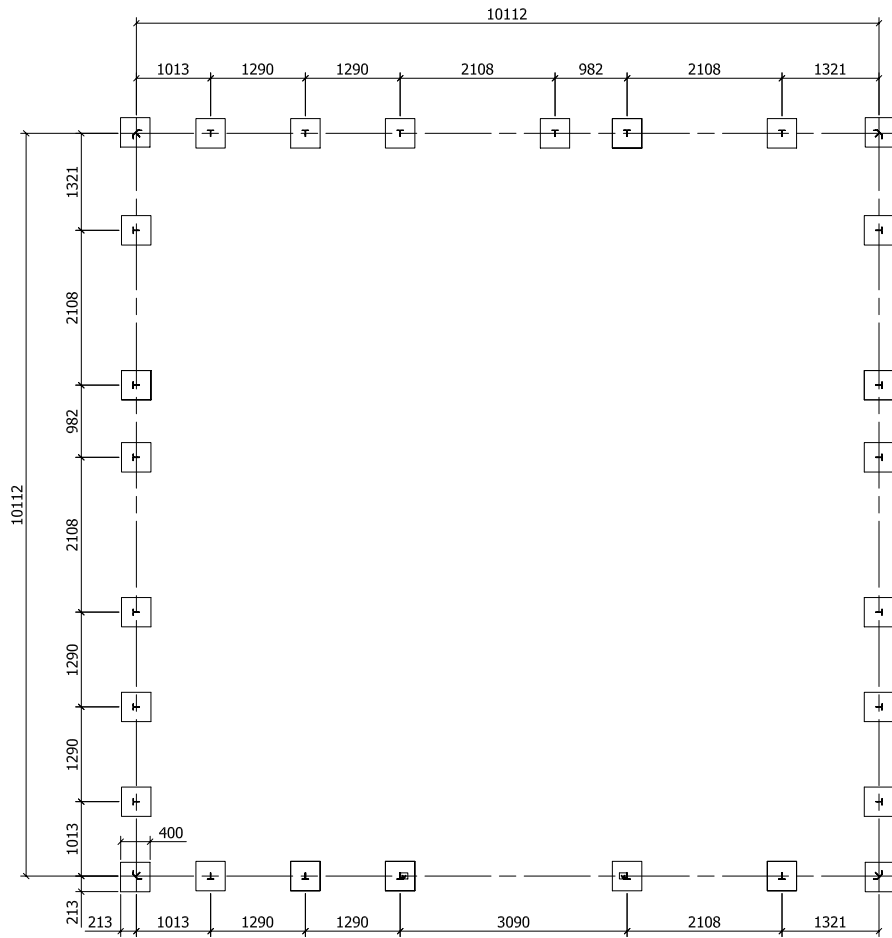

PLAN VIEW

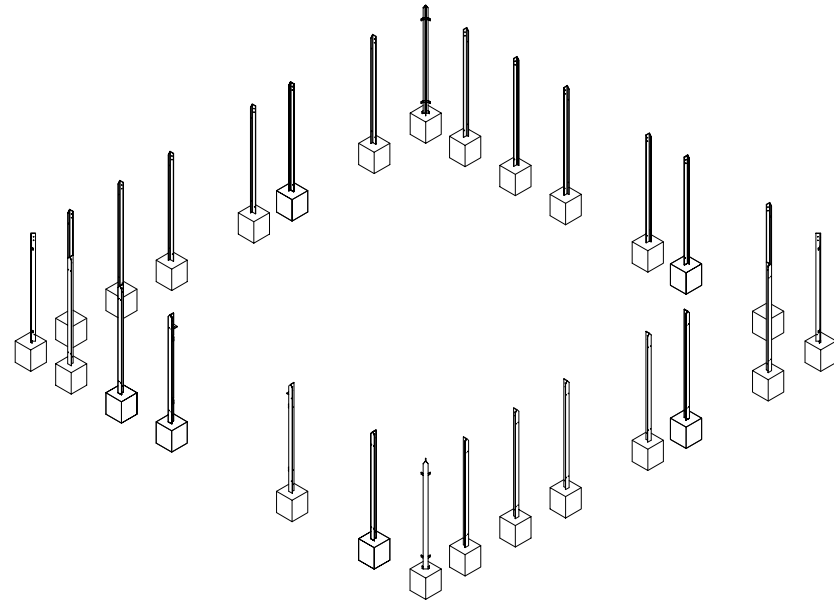

3D VIEW

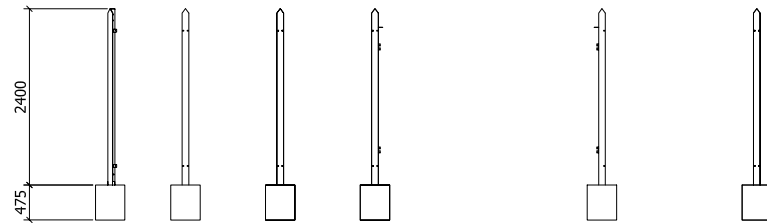

FRONT VIEW

D		DRN	KSRF	PRODUCT:	STDFN			
C		CHK	TRD.	TITLE:	GA. PLAN FOUNDATION 10.00 M.			
B		APP	PK					
A	09/07/2010 (ORIGINAL)	ORIGINAL SCALE	1 : 75	@ A3 - DO NOT SCALE THIS PRINT	THIRD ANGLE PROJECTION U.N.O. 	DRG.No	STDFN_FOUNDATION 10M	
ISSUE								