

PLAN VIEW

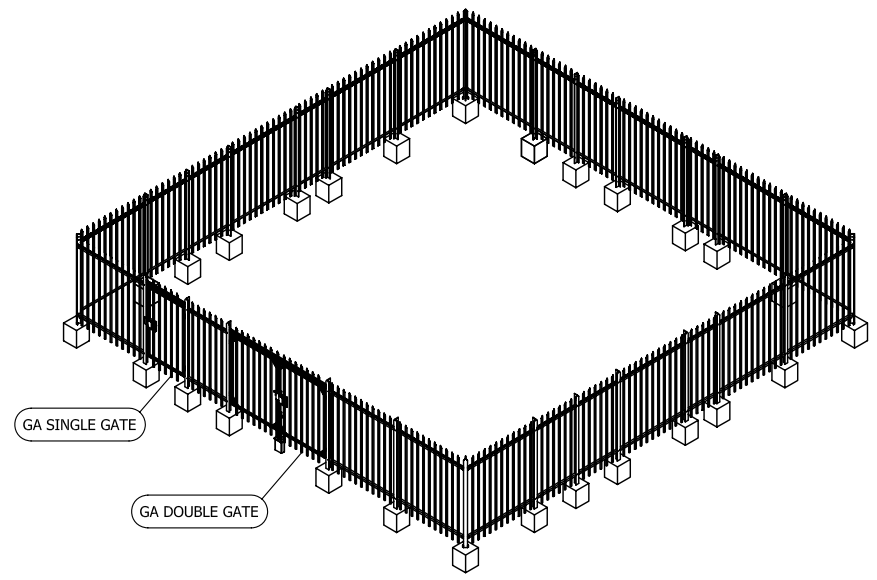

3D VIEW

D		DRN	KSRF	PRODUCT:	STDFN			
C		CHK	TRD.	TITLE:	GA. PLAN FOUNDATION 12.00 M.			
B		APP	PK					
A	14/06/2010 (ORIGINAL)	ORIGINAL SCALE	1 : 100	@ A3 - DO NOT SCALE THIS PRINT	THIRD ANGLE PROJECTION U.N.O.		DRG.No	STDFN_211_1of3
<b>ISSUE</b>								

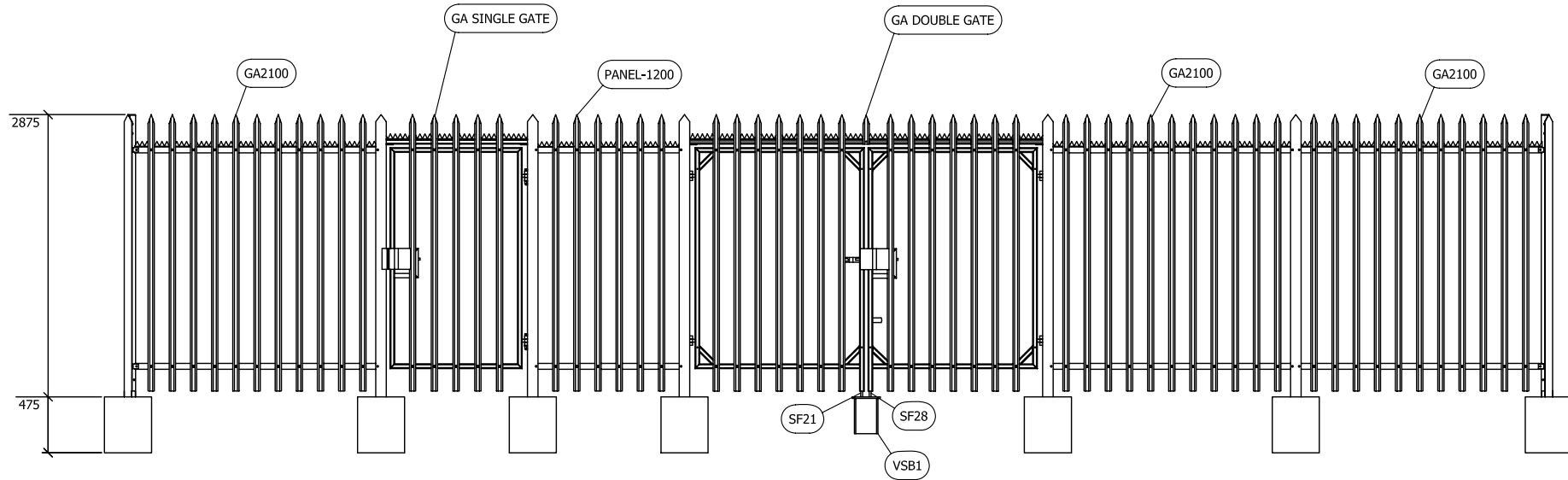

VIEW "A"

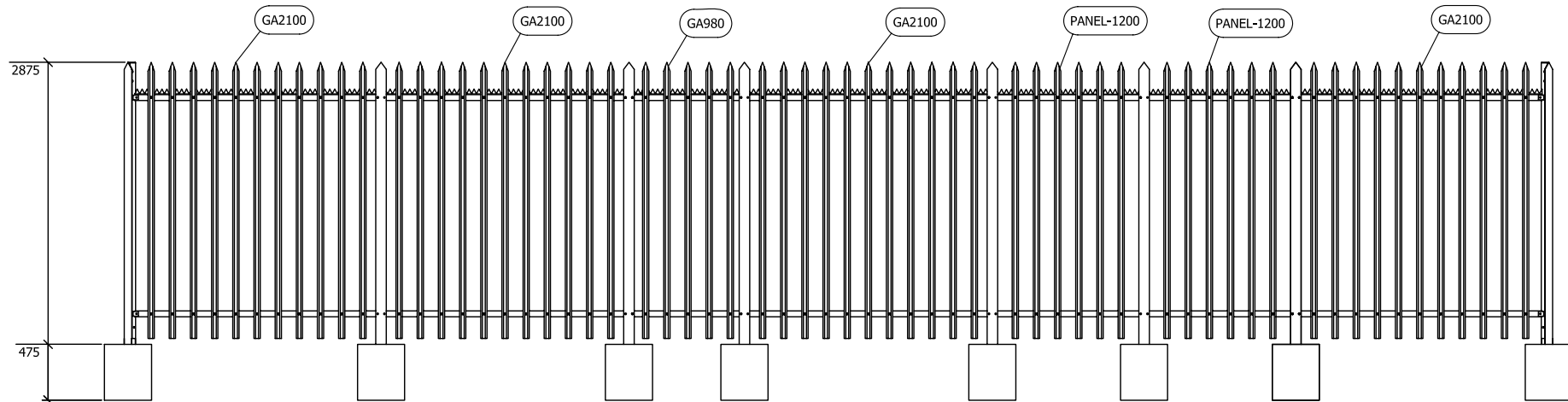

VIEW "C"

D		DRN	KSRF	PRODUCT:	STDFN			
C		CHK	TRD.	TITLE:	GA. PLAN FOUNDATION 12.00 M.			
B		APP	PK					
A	14/06/2010 (ORIGINAL)	ORIGINAL SCALE	1 : 40	@ A3 - DO NOT SCALE THIS PRINT	THIRD ANGLE PROJECTION U.N.O.	DRG.No	STDFN_211_2of3	
<b>ISSUE</b>								

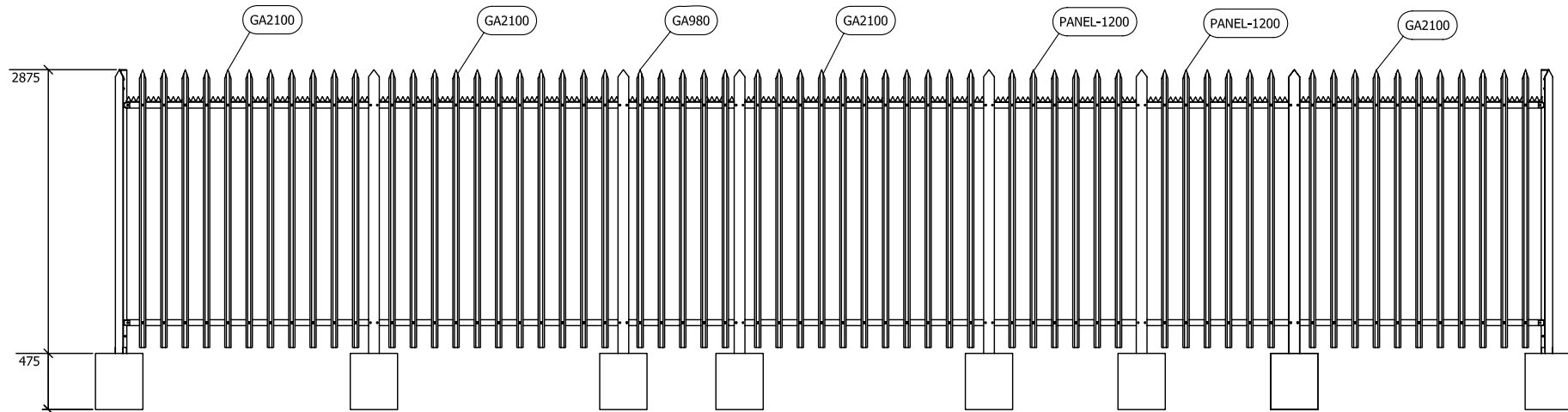

VIEW "B"

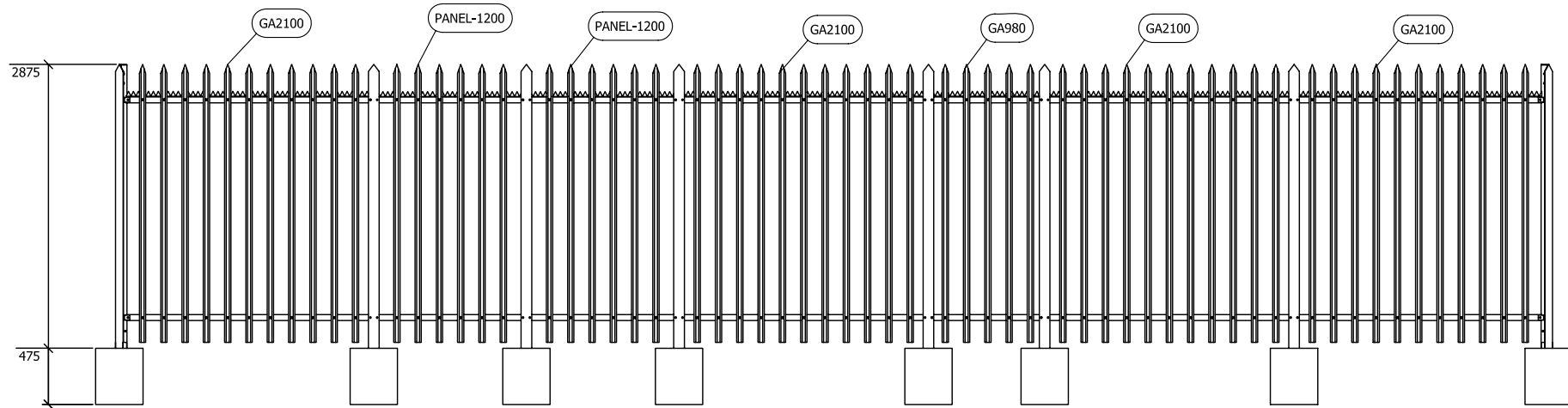

VIEW "D"

D		DRN	KSRF	PRODUCT:	STDFN			
C		CHK	TRD.	TITLE:	GA. PLAN FOUNDATION 12.00 M.			
B		APP	PK					
A	14/06/2010 (ORIGINAL)	ORIGINAL SCALE	1 : 40	@ A3 - DO NOT SCALE THIS PRINT	THIRD ANGLE PROJECTION U.N.O.	DRG.No	STDFN_211_3of3	
<b>ISSUE</b>								

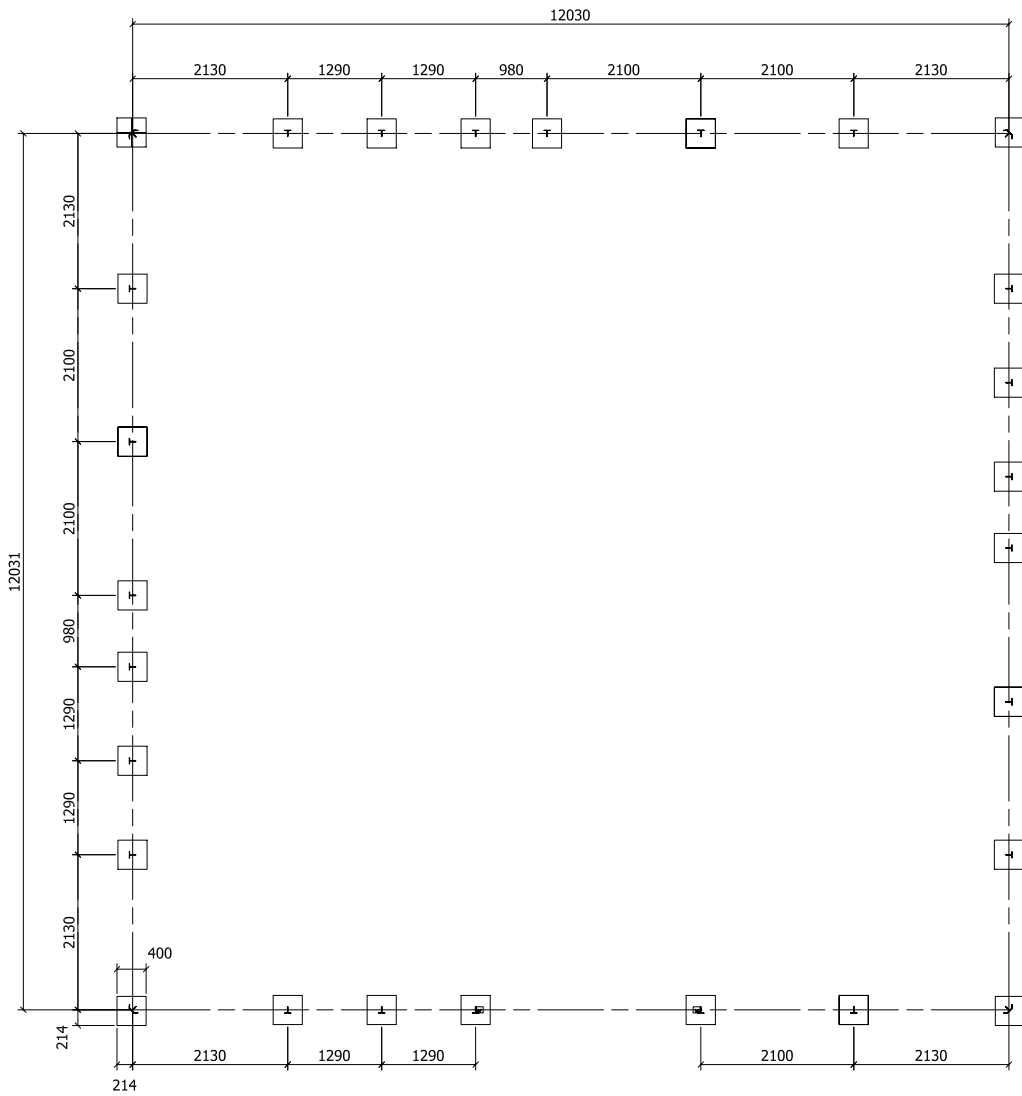

PLAN VIEW

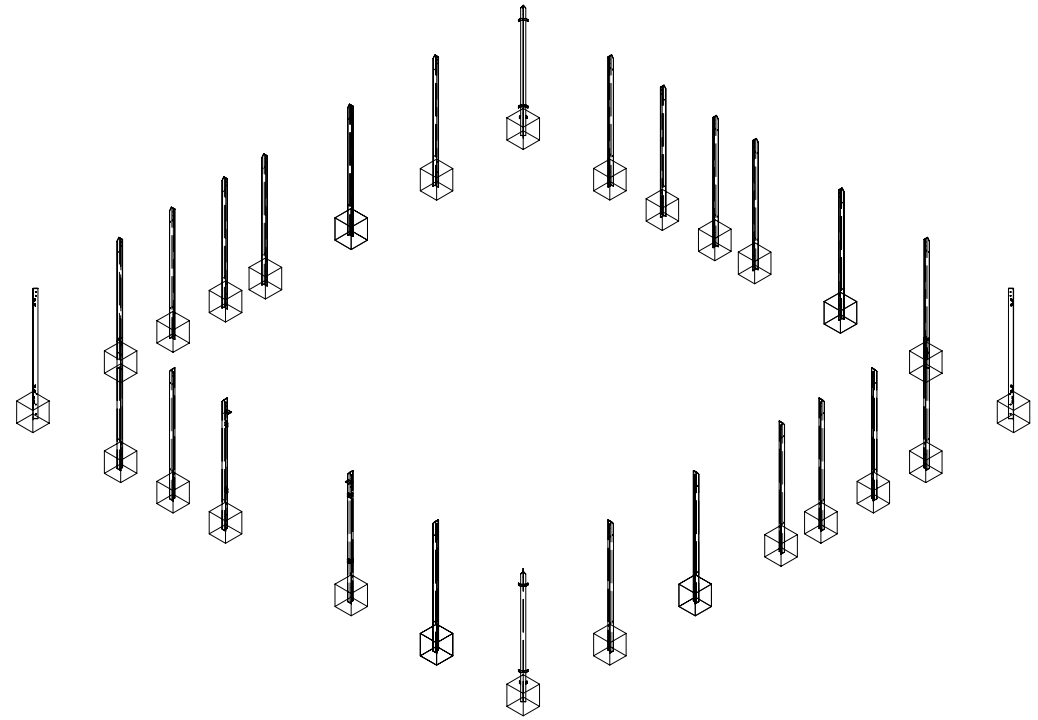

3D VIEW

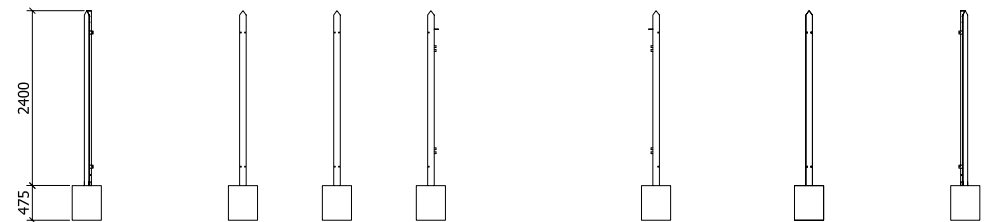

FRONT VIEW

D		DRN	KSRF	PRODUCT:	STDFN			
C		CHK	TRD.	TITLE:	GA. PLAN FOUNDATION 12.00 M.			
B		APP	PK					
A	09/07/2010 (ORIGINAL)	ORIGINAL SCALE	1 : 75	@ A3 - DO NOT SCALE THIS PRINT	THIRD ANGLE PROJECTION U.N.O.		DRG.No	STDFN_FOUNDATION 12M
<b>ISSUE</b>								